

iMilani

innovative
italian
ideas

ecodue-23

ITERIA 2000 INCORPORATE MOVINT

iMiNOW

MERITI IL MEGLIO... ADESSO



NEXIT

VALIDITÀ

01/07/2023 - 31/12/2023

CASSETTE E CONTENITORI IN PLASTICA PER INDUSTRIA E LOGISTICA

PERSONALIZZAZIONI

COLORI

2



MINIMO 200 PEZZI



PP 2X giallo segnale RAL 1003	PP 05 giallo RAL 1021	PP 1C giallo melone RAL 1028	PP HE arancio segnale RAL 2010	PP 24 arancio profondo RAL 2011
PP 2N rosso carminio RAL 3002	PP 1G rosso rubino RAL 3003	PP 03 rosso RAL 3020	PP JV violetto segnale RAL 4008	PP 3Z tele magenta RAL 4010
PP 04 blu PANTONE 660C	PP XB turchese PANTONE 2925C	PP 3P blu acqua RAL 5021	PP 27 blu segnale RAL 5005	PP IG blu zaffiro RAL 5003
PP QD verde foglia RAL 6002	PP JW verde plastica RAL 6011	PP 14 verde iMilani PANTONE 382C	PP 2F verde chiaro RAL 6027	PP 02 verde RAL 6032
PP 1B grigio segnale RAL 7004	PP XL grigio antracite RAL 7016	PP 08 grigio chiaro RAL 7035	PP 01 grigio RAL 7046	PP 07 nero RAL 9011

Colori a richiesta +7%

MARCHIATURA

Oltre all'applicazione di etichette adesive o IML per localizzazione in radiofrequenza RFID ed identificazione con barcode, è possibile personalizzare le cassette con il Vostro logo aziendale tramite due diversi sistemi, per quantità e spedizione entro 60 gg dall'approvazione dei disegni:

- Logo in rilievo nella cassetta, ottenuto durante la fase di stampaggio, quindi dello stesso colore della cassetta
- Marchiatura a caldo ottenuta tramite caratteri mobili oppure con cliché fedele al logo aziendale.

Colori disponibili:



MINIMO 500 PEZZI

Disponibile in tutti i colori



MINIMO 100 PEZZI

PER INFO E PERSONALIZZAZIONI - RICHIEDERE PREVENTIVO

Il nuovo progetto **NEXIT** offre una gamma completa di soluzioni per ogni necessità. Ogni singola dimensione di base EURO di questo programma è declinata in diverse altezze. Ogni singola altezza prevede varianti estetiche e funzionali. Disponibile nelle serie 200x150 - 300x200 - 400x300 - 600x400 con altezze da 75 - 120 - 170 - 220 - 270 - 320 - 420 mm.

SERIE 200x150



Dimensioni
200 x 150 x 75 h mm

NX	2108A	5101
Confezione pz.	📦	32
Fondo liscio	🔘	
Prezzo unitario	€ 3,01	



Dimensioni
200 x 150 x 120 h mm

NX	2112A	5101
Confezione pz.	📦	24
Fondo liscio	🔘	
Prezzo unitario	€ 3,30	

SERIE 300x200



Dimensioni
300 x 200 x 75 h mm

NX	3208A	5101
Confezione pz.	📦	20
Fondo liscio	🔘	
Prezzo unitario	€ 4,12	



Dimensioni
300 x 200 x 120 h mm

NX	3212A	5101
Confezione pz.	📦	16
Fondo liscio	🔘	
Prezzo unitario	€ 4,70	

SERIE 300x200



Dimensioni
300 x 200 x 170 h mm

NX	3217A	5101
Confezione pz.	📦	12
Fondo liscio	🔘	
Prezzo unitario	€ 5,38	



Dimensioni
300 x 200 x 220 h mm

NX	3222A	5101
Confezione pz.	📦	8
Fondo liscio	🔘	
Prezzo unitario	€ 6,06	



Coperchio incernierato a scatto



Coperchio separato

200x150	NX	21SE	5101
	Confezione pz.	📦	1
	Prezzo unitario	€ 1,74	



Coperchio incernierato

200x150	NX	21HG	5101
	Confezione pz.	📦	1
	Prezzo unitario	€ 1,74	



Coperchio incernierato a scatto

200x150	NX	21HH	5101
	Confezione pz.	📦	1
	Prezzo unitario	€ 1,74	



Portaetichette

300x200	NX	32SE	5101
	Confezione pz.	📦	1
	Prezzo unitario	€ 2,42	

300x200	NX	32HG	5101
	Confezione pz.	📦	1
	Prezzo unitario	€ 2,42	

300x200	NX	32HH	5101
	Confezione pz.	📦	1
	Prezzo unitario	€ 2,42	

LH	TYT
Confezione pz.	📦 10
Prezzo unitario	€ 0,67

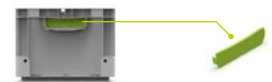

CARTER DI CHIUSURA MANIGLIE INCLUSO

SERIE

400x300

4



Dimensioni **400 x 300 x 75 h mm** Dimensioni **400 x 300 x 120 h mm** Dimensioni **400 x 300 x 120 h mm** Dimensioni **400 x 300 x 170 h mm** Dimensioni **400 x 300 x 170 h mm** Dimensioni **400 x 300 x 220 h mm**

NX 4308A 5101	NX 4312A 5101	NX 4312P 5101	NX 4317B 5101	NX 4317S 5101	NX 4322B 5101
Confezione pz. 14	Confezione pz. 8	Confezione pz. 8	Confezione pz. 6	Confezione pz. 6	Confezione pz. 4
Fondo liscio	Fondo liscio	Fondo forato rinf.	Fondo liscio	Fondo forato rinf.	Fondo liscio
Prezzo unitario € 6,47	Prezzo unitario € 7,23	Prezzo unitario € 9,52	Prezzo unitario € 8,53	Prezzo unitario € 10,72	Prezzo unitario € 9,51
NX 4308C 5101	NX 4312C 5101		NX 4317D 5101		NX 4322D 5101
Fondo rinforzato	Fondo rinforzato		Fondo rinforzato		Fondo rinforzato
Prezzo unitario € 9,40	Prezzo unitario € 9,52		Prezzo unitario € 10,72		Prezzo unitario € 11,52



Dimensioni **400 x 300 x 220 h mm** Dimensioni **400 x 300 x 220 h mm** Dimensioni **400 x 300 x 270 h mm** Dimensioni **400 x 300 x 270 h mm** Dimensioni **400 x 300 x 270 h mm** Dimensioni **400 x 300 x 320 h mm**

NX 4322S 5101	NX 4322U 5101	NX 4327B 5101	NX 4327S 5101	NX 4327U 5101	NX 4332B 5101
Confezione pz. 4	Confezione pz. 4	Confezione pz. 4	Confezione pz. 4	Confezione pz. 4	Confezione pz. 2
Fondo forato rinf.	Fondo liscio	Fondo liscio	Fondo forato rinf.	Fondo liscio	Fondo liscio
Prezzo unitario € 11,52	Prezzo unitario € 9,51	Prezzo unitario € 11,81	Prezzo unitario € 13,31	Prezzo unitario € 11,81	Prezzo unitario € 13,04
	NX WC4322 6896	NX 4327D 5101		NX WC4327 6896	NX 4332D 5101
	Confezione pz. 1	Fondo rinforzato		Confezione pz. 1	Fondo rinforzato
	Prezzo unitario € 2,09	Prezzo unitario € 13,31		Prezzo unitario € 2,28	Prezzo unitario € 14,53



Dimensioni **400 x 300 x 320 h mm** Dimensioni **400 x 300 x 320 h mm** Coperchio separato **400 x 300** Coperchio incernierato **400 x 300** Coperchio a due falde **400 x 300** Portaetichette

NX 4332S 5101	NX 4332U 5101	NX 43SE 5101	NX 43HG 5101	NX 43CR 5101	LH TYT
Confezione pz. 2	Confezione pz. 2	Confezione pz. 1	Confezione pz. 1	Confezione pz. 1	Confezione pz. 10
Fondo forato rinf.	Fondo liscio	Prezzo unitario € 4,32	Prezzo unitario € 4,32	Prezzo unitario € 8,23	Prezzo unitario € 0,67
Prezzo unitario € 14,53	Prezzo unitario € 13,04	600 x 400	600 x 400	600 x 400	
	NX WC4332 6896	NX 64SE 5101	NX 64HG 5101	NX 64CR 5101	
	Confezione pz. 1	Confezione pz. 1	Confezione pz. 1	Confezione pz. 1	
	Prezzo unitario € 2,47	Prezzo unitario € 6,98	Prezzo unitario € 6,98	Prezzo unitario € 12,52	



CARTER DI CHIUSURA MANIGLIE INCLUSO

SERIE 600x400

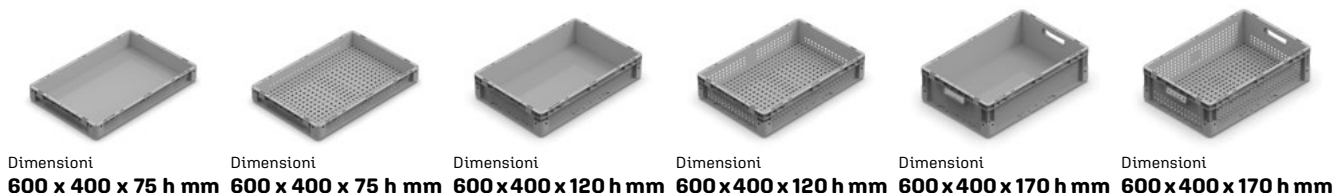

<p>Dimensioni 600 x 400 x 75 h mm</p> <p>NX 6408A 5101</p> <p>Confezione pz. 7</p> <p>Fondo liscio </p> <p>Prezzo unitario € 8,90</p>	<p>Dimensioni 600 x 400 x 75 h mm</p> <p>NX 6408P 5101</p> <p>Confezione pz. 7</p> <p>Fondo forato rinf. </p> <p>Prezzo unitario € 12,37</p>	<p>Dimensioni 600 x 400 x 120 h mm</p> <p>NX 6412A 5101</p> <p>Confezione pz. 4</p> <p>Fondo liscio </p> <p>Prezzo unitario € 10,25</p>	<p>Dimensioni 600 x 400 x 120 h mm</p> <p>NX 6412P 5101</p> <p>Confezione pz. 4</p> <p>Fondo forato rinf. </p> <p>Prezzo unitario € 13,42</p>	<p>Dimensioni 600 x 400 x 170 h mm</p> <p>NX 6417B 5101</p> <p>Confezione pz. 3</p> <p>Fondo liscio </p> <p>Prezzo unitario € 11,67</p>	<p>Dimensioni 600 x 400 x 170 h mm</p> <p>NX 6417S 5101</p> <p>Confezione pz. 3</p> <p>Fondo forato rinf. </p> <p>Prezzo unitario € 15,46</p>
<p>NX 6408C 5101</p> <p>Fondo rinforzato </p> <p>Prezzo unitario € 12,37</p>		<p>NX 6412C 5101</p> <p>Fondo rinforzato </p> <p>Prezzo unitario € 13,42</p>		<p>NX 6417D 5101</p> <p>Fondo rinforzato </p> <p>Prezzo unitario € 15,46</p>	

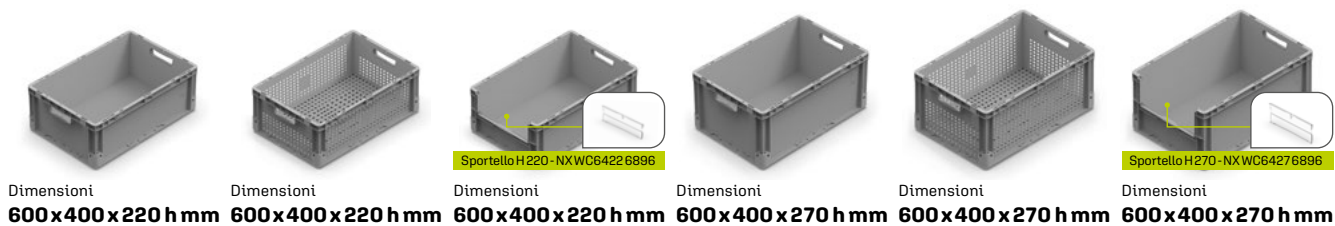

<p>Dimensioni 600 x 400 x 220 h mm</p> <p>NX 6422B 5101</p> <p>Confezione pz. 2</p> <p>Fondo liscio </p> <p>Prezzo unitario € 15,28</p>	<p>Dimensioni 600 x 400 x 220 h mm</p> <p>NX 6422S 5101</p> <p>Confezione pz. 2</p> <p>Fondo forato rinf. </p> <p>Prezzo unitario € 18,31</p>	<p>Dimensioni 600 x 400 x 220 h mm</p> <p>NX 6422U 5101</p> <p>Confezione pz. 2</p> <p>Fondo liscio </p> <p>Prezzo unitario € 15,28</p>	<p>Dimensioni 600 x 400 x 270 h mm</p> <p>NX 6427B 5101</p> <p>Confezione pz. 2</p> <p>Fondo liscio </p> <p>Prezzo unitario € 18,66</p>	<p>Dimensioni 600 x 400 x 270 h mm</p> <p>NX 6427S 5101</p> <p>Confezione pz. 2</p> <p>Fondo forato rinf. </p> <p>Prezzo unitario € 23,32</p>	<p>Dimensioni 600 x 400 x 270 h mm</p> <p>NX 6427U 5101</p> <p>Confezione pz. 2</p> <p>Fondo liscio </p> <p>Prezzo unitario € 18,66</p>
<p>NX 6422D 5101</p> <p>Fondo rinforzato </p> <p>Prezzo unitario € 18,31</p>		<p>NX WC6422 6896</p> <p>Confezione pz. 1</p> <p>Prezzo unitario € 2,28</p>	<p>NX 6427D 5101</p> <p>Fondo rinforzato </p> <p>Prezzo unitario € 23,32</p>		<p>NX WC6427 6896</p> <p>Confezione pz. 1</p> <p>Prezzo unitario € 2,47</p>

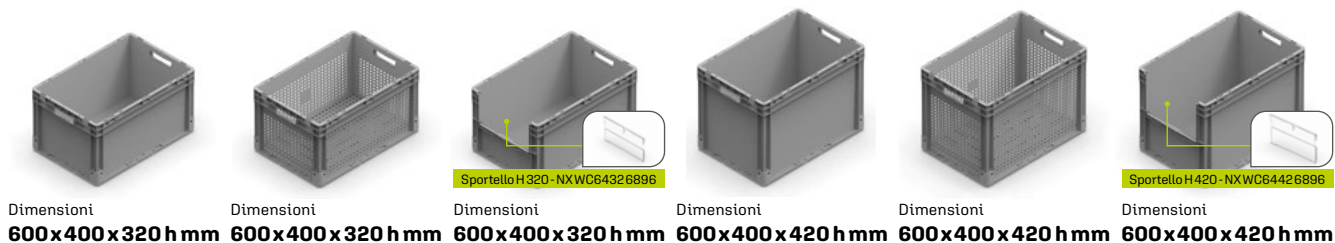

<p>Dimensioni 600 x 400 x 320 h mm</p> <p>NX 6432B 5101</p> <p>Confezione pz. 3</p> <p>Fondo liscio </p> <p>Prezzo unitario € 21,01</p>	<p>Dimensioni 600 x 400 x 320 h mm</p> <p>NX 6432S 5101</p> <p>Confezione pz. 3</p> <p>Fondo forato rinf. </p> <p>Prezzo unitario € 24,24</p>	<p>Dimensioni 600 x 400 x 320 h mm</p> <p>NX 6432U 5101</p> <p>Confezione pz. 3</p> <p>Fondo liscio </p> <p>Prezzo unitario € 21,01</p>	<p>Dimensioni 600 x 400 x 420 h mm</p> <p>NX 6442B 5101</p> <p>Confezione pz. 1</p> <p>Fondo liscio </p> <p>Prezzo unitario € 28,10</p>	<p>Dimensioni 600 x 400 x 420 h mm</p> <p>NX 6442S 5101</p> <p>Confezione pz. 1</p> <p>Fondo forato rinf. </p> <p>Prezzo unitario € 30,03</p>	<p>Dimensioni 600 x 400 x 420 h mm</p> <p>NX 6442U 5101</p> <p>Confezione pz. 1</p> <p>Fondo liscio </p> <p>Prezzo unitario € 28,10</p>
<p>NX 6432D 5101</p> <p>Fondo rinforzato </p> <p>Prezzo unitario € 24,24</p>		<p>NX WC6432 6896</p> <p>Confezione pz. 1</p> <p>Prezzo unitario € 2,67</p>	<p>NX 6442D 5101</p> <p>Fondo rinforzato </p> <p>Prezzo unitario € 30,03</p>		<p>NX WC6442 6896</p> <p>Confezione pz. 1</p> <p>Prezzo unitario € 2,86</p>



ECOGREEN



Fondo liscio

PORTATA 20 KG

6

SERIE 200x150



Dimensioni
200 x 150 x 75 h mm

Dimensioni
200 x 150 x 120 h mm

Dimensioni
300 x 200 x 75 h mm

Dimensioni
300 x 200 x 120 h mm

Dimensioni
300 x 200 x 170 h mm

Dimensioni
300 x 200 x 220 h mm

NX 2108A 5401	NX 2112A 5401	NX 3208A 5401	NX 3212A 5401	NX 3217A 5401	NX 3222A 5401
Confezione pz. 32	Confezione pz. 24	Confezione pz. 20	Confezione pz. 16	Confezione pz. 12	Confezione pz. 8
Fondo liscio <input type="checkbox"/>	Fondo liscio <input type="checkbox"/>	Fondo liscio <input type="checkbox"/>	Fondo liscio <input type="checkbox"/>	Fondo liscio <input type="checkbox"/>	Fondo liscio <input type="checkbox"/>
Prezzo unitario € 2,56	Prezzo unitario € 2,80	Prezzo unitario € 3,50	Prezzo unitario € 4,00	Prezzo unitario € 4,58	Prezzo unitario € 5,15

SERIE 400x300



Dimensioni
400 x 300 x 75 h mm

Dimensioni
400 x 300 x 120 h mm

Dimensioni
400 x 300 x 170 h mm

Dimensioni
400 x 300 x 220 h mm

Dimensioni
400 x 300 x 270 h mm

Dimensioni
400 x 300 x 320 h mm

NX 4308A 5401	NX 4312A 5401	NX 4317A 5401	NX 4322A 5401	NX 4327A 5401	NX 4332A 5401
Confezione pz. 14	Confezione pz. 8	Confezione pz. 6	Confezione pz. 4	Confezione pz. 4	Confezione pz. 2
Fondo liscio <input type="checkbox"/>	Fondo liscio <input type="checkbox"/>	Fondo liscio <input type="checkbox"/>	Fondo liscio <input type="checkbox"/>	Fondo liscio <input type="checkbox"/>	Fondo liscio <input type="checkbox"/>
Prezzo unitario € 5,50	Prezzo unitario € 6,14	Prezzo unitario € 7,25	Prezzo unitario € 8,08	Prezzo unitario € 10,04	Prezzo unitario € 11,08



Coperchio separato



Coperchio incernierato



Coperchio incernierato
a scatto



Coperchio separato



Coperchio incernierato



Coperchio a due falde

200 x 150

200 x 150

200 x 150

400 x 300

400 x 300

400 x 300

NX 21SE 5401	NX 21HG 5401	NX 21HH 5401	NX 43SE 5401	NX 43HG 5401	NX 43CR 5401
Confezione pz. 1	Confezione pz. 1	Confezione pz. 1	Confezione pz. 1	Confezione pz. 1	Confezione pz. 1
Prezzo unitario € 1,47	Prezzo unitario € 1,47	Prezzo unitario € 1,47	Prezzo unitario € 3,67	Prezzo unitario € 3,67	Prezzo unitario € 6,99
300 x 200			300 x 200		
NX 32SE 5401	NX 32HG 5401	NX 32HH 5401			
Confezione pz. 1	Confezione pz. 1	Confezione pz. 1			
Prezzo unitario € 2,06	Prezzo unitario € 2,06	Prezzo unitario € 2,06			



Fondo liscio

PORTATA 20 KG



MANIGLIE APERTE

H 270 - 320 - 420



CARTER DI CHIUSURA MANIGLIE INCLUSO *

* forniti montati

SERIE 600x400



Dimensioni
600 x 400 x 75 h mm

NX 6408A	5401
Confezione pz.	7
Fondo liscio	<input type="checkbox"/>
Prezzo unitario	€ 7,57



Dimensioni
600 x 400 x 120 h mm

NX 6412A	5401
Confezione pz.	4
Fondo liscio	<input type="checkbox"/>
Prezzo unitario	€ 8,71



Dimensioni
600 x 400 x 170 h mm

NX 6417A	5401
Confezione pz.	3
Fondo liscio	<input type="checkbox"/>
Prezzo unitario	€ 9,92



Dimensioni
600 x 400 x 220 h mm

NX 6422A	5401
Confezione pz.	2
Fondo liscio	<input type="checkbox"/>
Prezzo unitario	€ 12,99



Dimensioni
600 x 400 x 270 h mm

NX 6427B	5401
Confezione pz.	2
Fondo liscio	<input type="checkbox"/>
Prezzo unitario	€ 15,86



Dimensioni
600 x 400 x 320 h mm

NX 6432B	5401
Confezione pz.	3
Fondo liscio	<input type="checkbox"/>
Prezzo unitario	€ 17,86



Dimensioni
600 x 400 x 420 h mm

NX 6442B	5401
Confezione pz.	1
Fondo liscio	<input type="checkbox"/>
Prezzo unitario	€ 23,88



Portaetichette

LH	TYT
Confezione pz.	10
Prezzo unitario	€ 0,67



Coperchio separato



Coperchio incernierato



Coperchio a due falde



Cover

NX 64SE	5401
Confezione pz.	1
Prezzo unitario	€ 5,94

NX 64HG	5401
Confezione pz.	1
Prezzo unitario	€ 5,94

NX 64CR	5401
Confezione pz.	1
Prezzo unitario	€ 10,64

NX 64CV	5401
Confezione pz.	1
Prezzo unitario	€ 6,74

NEXIT 86

LOGISTIC



8

SERIE 800x600



Fondo rinforzato con cornice perimetrale sandwich.

PORTATA 80 KG



Fondo rinforzato con cornice perimetrale sandwich e barre di rinforzo in acciaio.

PORTATA 200 KG



Dimensioni
800 x 600 x 420 h mm



Dimensioni
800 x 600 x 420 h mm



Dimensioni
800 x 600 x 420 h mm



Dimensioni
800 x 600 x 520 h mm

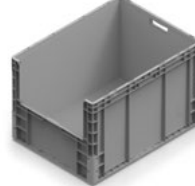

Dimensioni
800 x 600 x 520 h mm



Dimensioni
800 x 600 x 520 h mm

NX 8642D 5101	NX 8642T 5101	NX 8642W 5101	NX 8652D 5101	NX 8652T 5101	NX 8652W 5101
Confezione pz. 1	Confezione pz. 1	Confezione pz. 1	Confezione pz. 1	Confezione pz. 1	Confezione pz. 1
Prezzo unitario €70,00	Prezzo unitario €70,00	Prezzo unitario €70,00	Prezzo unitario €79,00	Prezzo unitario €79,00	Prezzo unitario €79,00

Coperchio separato

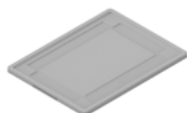

Dimensioni
800 x 600 mm

NX 86SE 5101
Confezione pz. 1
Prezzo unitario €18,00

Coperchio a due falde



Dimensioni
800 x 600 mm

NX 86CR 5101
Confezione pz. 1
Prezzo unitario €28,00



NX WC8642 6896
Confezione pz. 1
Prezzo unitario €7,60



NX WC8652 6896
Confezione pz. 1
Prezzo unitario €8,90

Slitta di inforcamento
SOLO
per carrello elevatore



NX RUNN2 5107
<input checked="" type="checkbox"/> Ordinare 2 pezzi
Accessori forniti montati
Prezzo unitario €11,00



slitte di inforcamento



ATHENA 86

LOGISTIC

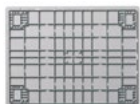

Fondo rinforzato
PORTATA 60 KG



con piedini



con piedini + traverse



con ruote

SERIE 800x600



Dimensioni
800 x 600 x 120 h mm



Dimensioni
800 x 600 x 170 h mm



Dimensioni
800 x 600 x 220 h mm



Dimensioni
800 x 600 x 320 h mm



Dimensioni
800 x 600 x 430 h mm

Coperchio separato



Dimensioni
800 x 600 mm

AT 8612C 5101	AT 8617C 5101	AT 8622C 5101	AT 8632C 5101	AT 8643C 5101	AT 86SE 5101
Confezione pz. 4	Confezione pz. 3	Confezione pz. 2	Confezione pz. 2	Confezione pz. 1	Confezione pz. 5
Prezzo unitario €33,25	Prezzo unitario €35,79	Prezzo unitario €37,02	Prezzo unitario €42,01	Prezzo unitario €48,58	Prezzo unitario €13,71



Piede h 100 mm



Traversa h 25 mm



Molla blocco documenti
in acciaio



senza freno



con freno



senza freno

AT FEET 5101	AT RUNN 5101	SPRING 0099	AT WRCF 100	AT WRBT 100	AT WRCT 100
<input checked="" type="checkbox"/> Ordinare 4 piedi	<input checked="" type="checkbox"/> Ordinare 2 pezzi	Confezione pz. 10	Ruota fissa in gomma diametro 100 mm	Ruota girevole in gomma diametro 100 mm	Ruota girevole in gomma diametro 100 mm
Accessori forniti montati	Accessori forniti montati	Accessori forniti montati	<input checked="" type="checkbox"/> Ordinare 4 ruote	<input checked="" type="checkbox"/> Ordinare 4 ruote	<input checked="" type="checkbox"/> Ordinare 4 ruote
Prezzo unitario €3,96	Prezzo unitario €5,28	Prezzo unitario €0,35	Prezzo unitario €9,38	Prezzo unitario €14,84	Prezzo unitario €12,00

SERIE 400x300



Dimensioni
400 x 300 x 220 h mm

Coperchio incernierato



Dimensioni
400 x 300 mm



Dimensioni
600 x 400 x 120 h mm



Dimensioni
600 x 400 x 220 h mm



Dimensioni
600 x 400 x 325 h mm

Coperchio incernierato



Dimensioni
600 x 400 mm

AT 4322A ISO	AT 43HG ISO	AT 6412A ISO	AT 6422A ISO	AT 6432A ISO	AT 64HG ISO
Confezione pz. 4	Confezione pz. 10	Confezione pz. 4	Confezione pz. 2	Confezione pz. 3	Confezione pz. 10
Prezzo unitario €14,32	Prezzo unitario €5,69	Prezzo unitario €17,25	Prezzo unitario €27,51	Prezzo unitario €35,79	Prezzo unitario €11,30

ATHENA ISO

NON CONFORME • NON-COMPLIANT



KRONOS

SPACE SAVER



Le cassette abbattibili **KRONOS** sono state specificatamente progettate e realizzate per ridurre sensibilmente lo spazio di ingombro quando non utilizzate e nel trasporto dei vuoti. La riduzione del loro volume fino al **75%** consente quindi un elevato risparmio nei costi di immagazzinaggio e di trasporto.

10



**RIDUZIONE DEL VOLUME
FINO AL 75%**

SERIE 400x300



Dimensioni
400 x 300 x 220 h mm
Altezza chiusa **80 mm**

KR 4322B 5101
Confezione pz. 10
Prezzo unitario **€17,39**

SERIE 600x400



Dimensioni
600 x 400 x 220 h mm
Altezza chiusa **80 mm**

KR 6422B 5101
Confezione pz. 5
Prezzo unitario **€23,78**



Dimensioni
600 x 400 x 320 h mm
Altezza chiusa **80 mm**

KR 6432B 5101
Confezione pz. 5
Prezzo unitario **€27,14**

ABBATTIBILITÀ

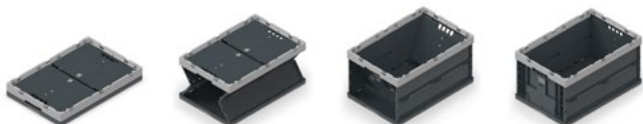

SERIE 600x400



Dimensioni
600 x 400 x 420 h mm
Altezza chiusa **100 mm**

KR 6442B 5101
Confezione pz. 4
Prezzo unitario **€32,34**

SERIE 800x400



Dimensioni
800 x 400 x 420 h mm
Altezza chiusa **100 mm**

KR 8442B 5101
Confezione pz. 4
Prezzo unitario **€47,70**

PERSONALIZZAZIONE COLORE CORNICE SU RICHIESTA

MINIMO DI 200 PEZZI
(con sovrapprezzo)



Coperchio incernierato
a due falde

KR 43HG 51XL
400 x 300 mm

Confezione pz. 10
Prezzo unitario **€3,73**



Coperchio incernierato
a due falde

KR 64HG 51XL
600 x 400 mm

Confezione pz. 10
Prezzo unitario **€5,92**



Coperchio incernierato
a due falde

KR 84HG 51XL
800 x 400 mm

Confezione pz. 10
Prezzo unitario **€8,87**



Carter di chiusura maniglie

KR PLUG 5101

Confezione pz. 10
Prezzo unitario **€0,36**



Sigillo monouso di sicurezza

KR SEAL 5113

Confezione pz. 500
Prezzo unitario **€0,11**

DELTA

SPACE SAVER



Le cassette serie **DELTA** presentano una struttura tronco-conica: a pieno carico sono sovrapponibili in modo stabile e sicuro, a vuoto si inseriscono l'una dentro l'altra con una riduzione del **70%** del loro volume. Per queste caratteristiche vengono utilizzate per consentire l'ideale sfruttamento degli spazi in magazzino e soprattutto nel trasporto.



**RIDUZIONE DEL VOLUME
FINO AL 70%**

11

VERSIONE

A



Dimensioni **600 x 400 x 175 h mm** Dimensioni **600 x 400 x 225 h mm** Dimensioni **600 x 400 x 275 h mm** Dimensioni **600 x 400 x 325 h mm** Dimensioni **600 x 400 x 425 h mm** Coperchio separato

DE 6417A 5101	DE 6422A 5101	DE 6427A 5101	DE 6432A 5101	DE 6442A 5101	DE 64SE 5101
Confezione pz. 5	Confezione pz. 5	Confezione pz. 5	Confezione pz. 4	Confezione pz. 3	Confezione pz. 1
Prezzo unitario €13,31	Prezzo unitario €14,56	Prezzo unitario €18,01	Prezzo unitario €19,51	Prezzo unitario €25,13	Prezzo unitario €11,36

VERSIONE

I



Dimensioni **600 x 400 x 180 h mm** Dimensioni **600 x 400 x 230 h mm** Dimensioni **600 x 400 x 280 h mm** Dimensioni **600 x 400 x 330 h mm** Dimensioni **600 x 400 x 430 h mm** Sigillo monouso di sicurezza

DE 6417I 5101	DE 6422I 5101	DE 6427I 5101	DE 6432I 5101	DE 6442I 5101	DE SEAL 5113
Confezione pz. 5	Confezione pz. 5	Confezione pz. 5	Confezione pz. 4	Confezione pz. 3	Confezione pz. 500
Prezzo unitario €18,60	Prezzo unitario €19,85	Prezzo unitario €23,29	Prezzo unitario €24,81	Prezzo unitario €30,45	Prezzo unitario €0,11

VERSIONE

Z



Dimensioni **600 x 400 x 190 h mm** Dimensioni **600 x 400 x 240 h mm** Dimensioni **600 x 400 x 290 h mm** Dimensioni **600 x 400 x 340 h mm** Dimensioni **600 x 400 x 440 h mm**

DE 6417Z 5101	DE 6422Z 5101	DE 6427Z 5101	DE 6432Z 5101	DE 6442Z 5101
Confezione pz. 5	Confezione pz. 5	Confezione pz. 5	Confezione pz. 4	Confezione pz. 3
Prezzo unitario €26,87	Prezzo unitario €28,12	Prezzo unitario €31,56	Prezzo unitario €33,10	Prezzo unitario €38,68

iMilani
Innovative Italian Ideas

ZEUS

C-PARTS



Le cassette serie **ZEUS** rispondono alle più specifiche esigenze di contenimento, movimentazione e stoccaggio delle merci. Maneggevoli, leggere e facili da pulire grazie all'interno perfettamente liscio, sono dotate di un robusto bordo che consente la sovrapposizione in modo stabile e sicuro.

12



MISURA 701



Dimensioni
144 x 91 x 70 h mm

COLORE	ZE	Z701	5101
	ZE	Z701	5102
	ZE	Z701	5103
	ZE	Z701	5104
	ZE	Z701	5105
	Confezione pz. 50		
Prezzo unitario €1,50			

MISURA 702



Dimensioni
144 x 139 x 70 h mm

COLORE	ZE	Z702	5101
	ZE	Z702	5102
	ZE	Z702	5103
	ZE	Z702	5104
	ZE	Z702	5105
	Confezione pz. 30		
Prezzo unitario €1,83			

MISURA 272-2



Dimensioni
211 x 148 x 126 h mm

COLORE	ZE	Z002	5101
	ZE	Z002	5102
	ZE	Z002	5103
	ZE	Z002	5104
	ZE	Z002	5105
	Confezione pz. 54		
Prezzo unitario €3,07			



MISURA 272-3A2



Dimensioni
310 x 210 x 145 h mm

COLORE	ZE	Z3A2	5101
	ZE	Z3A2	5102
	ZE	Z3A2	5103
	ZE	Z3A2	5104
	ZE	Z3A2	5105
	Confezione pz. 21		
Prezzo unitario €5,41			

MISURA 272-4A2



Dimensioni
465 x 315 x 120 h mm

COLORE	ZE	Z4A2	5101
	ZE	Z4A2	5102
	ZE	Z4A2	5103
	ZE	Z4A2	5104
	ZE	Z4A2	5105
	Confezione pz. 16		
Prezzo unitario €9,35			

MISURA 272-4



Dimensioni
465 x 315 x 200 h mm

COLORE	ZE	Z004	5101
	ZE	Z004	5102
	ZE	Z004	5103
	ZE	Z004	5104
	ZE	Z004	5105
	Confezione pz. 10		
Prezzo unitario €11,51			

MISURA 272-4A5



Dimensioni
465 x 315 x 300 h mm

COLORE	ZE	Z4A5	5101
	ZE	Z4A5	5102
	ZE	Z4A5	5103
	ZE	Z4A5	5104
	ZE	Z4A5	5105
	Confezione pz. 6		
Prezzo unitario €15,58			

PRACTIBOX

C-PARTS



Le cassettiere serie **PRACTIBOX** sono composte da una struttura in ABS di colore grigio e da cassette in polistirolo trasparente ad alta resistenza meccanica. Disponibili in modelli diversi, per profondità ed altezza, hanno in comune la larghezza di 600 mm che permette di sovrapporli consentendo le più svariate combinazioni. L'abbinamento con i pannelli posteriori in acciaio consente di organizzare e razionalizzare lo spazio.

13



Telaio posteriore
per installazione a parete

PR F100 0001

600x41x1000 h mm

Prezzo unitario € 35,41

PR F150 0001

600x41x1500 h mm

Prezzo unitario € 36,39

PR F195 0001

600x41x1950 h mm

Prezzo unitario € 41,41



Cassettiere con 9 cassette

Dimensioni
600 x 69 x 77 h mm

PR 9077 0001

Confezione pz. 2

Prezzo unitario € 15,00



Cassettiere con 6 cassette

Dimensioni
600 x 98 x 112 h mm

PR 6112 0001

Confezione pz. 2

Prezzo unitario € 18,32



Cassettiere con 5 cassette

Dimensioni
600 x 141 x 164 h mm

PR 5164 0001

Confezione pz. 1

Prezzo unitario € 29,16



Cassettiere con 4 cassette

Dimensioni
600 x 174 x 206 h mm

PR 4206 0001

Confezione pz. 1

Prezzo unitario € 38,31



Cassettiere con 3 cassette

Dimensioni
600 x 209 x 240 h mm

PR 3240 0001

Confezione pz. 1

Prezzo unitario € 44,99



Cassettiere con 2 cassette

Dimensioni
600 x 311 x 353 h mm

PR 2353 0001

Confezione pz. 1

Prezzo unitario € 84,14



Abbinabile al telaio posteriore
per posizionamento libero

Dimensioni
600 x 300 x 100 h mm

PR DBAS 0001

Base opzionale

Prezzo unitario € 47,20



Dimensioni
600 x 28 x 500 h mm

PR F050 0001

Pannello posteriore

Prezzo unitario € 21,90



Dimensioni
600 x 150 x 500 h mm

PR D050 0001

Telaio da banco
senza cassette

Prezzo unitario € 39,87



innovative
italian
ideas
imilani

COMPAT

C-PARTS



I contenitori serie **COMPAT** sono la soluzione ideale ad ogni problema di stoccaggio: in magazzino, in officina, lungo le linee di montaggio. Consentono di avere sempre a portata di mano e ben in vista il contenuto, rendendolo prelevabile con estrema facilità.

14

MISURA 1



Dimensioni
169/136 x 103 x 75 h mm

COLORE	CO	C001	5101
	CO	C001	5102
	CO	C001	5103
	CO	C001	5104
	CO	C001	5105
	Confezione pz. 50		
Prezzo unitario €1,14			

MISURA 2



Dimensioni
230/202x150x125hmm

COLORE	CO	C002	5101
	CO	C002	5102
	CO	C002	5103
	CO	C002	5104
	CO	C002	5105
	Confezione pz. 54		
Prezzo unitario €2,22			

MISURA 3A2



Dimensioni
350/296x210x145hmm

COLORE	CO	C3A2	5101
	CO	C3A2	5102
	CO	C3A2	5103
	CO	C3A2	5104
	CO	C3A2	5105
	Confezione pz. 21		
Prezzo unitario €5,30			

MISURA 3



Dimensioni
350/291x210x200hmm

COLORE	CO	C003	5101
	CO	C003	5102
	CO	C003	5103
	CO	C003	5104
	CO	C003	5105
	Confezione pz. 15		
Prezzo unitario €6,26			



CO	C1S2	5407
Divisorio 2 scomparti per misura 1		
Confezione pz. 25		
Prezzo unitario €1,39		



CO	C2S2	5407
Divisorio 2 scomparti per misura 2		
Confezione pz. 25		
Prezzo unitario €1,88		



CD	C3A2	7107
Divisorio longit. in plastica per misura 3A2		
Confezione pz. 10		
Prezzo unitario €2,14		

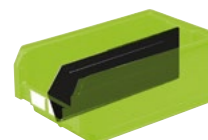

CD	C003	7107
Divisorio longit. in plastica per misura 3		
Confezione pz. 10		
Prezzo unitario €2,80		



CO	C1S4	5407
Divisorio 4 scomparti per misura 1		
Confezione pz. 25		
Prezzo unitario €1,39		



CO	C2S4	5407
Divisorio 4 scomparti per misura 2		
Confezione pz. 25		
Prezzo unitario €1,88		



I contenitori Compat possono essere suddivisi longitudinalmente e trasversalmente per le unità di carico con più prodotti al loro interno.

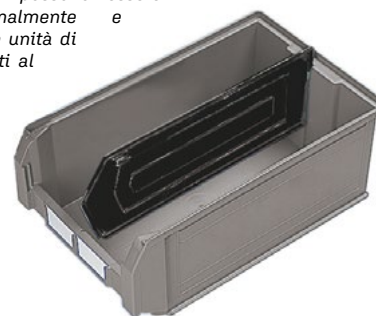

COMPAT

C-PARTS



I contenitori a bocca di lupo **COMPAT** sono impilabili in modo stabile e sicuro e la pronta disponibilità del materiale non viene meno anche quando sono sovrapposti. Un rinforzo laterale sul fondo permette di accatastare i contenitori con la massima sicurezza anche a pieno carico.

MISURA 4A2



Dimensioni
500/450 x 310 x 145 h mm

MISURA 4



Dimensioni
500/443 x 310 x 200 h mm

MISURA 4A5



Dimensioni
500/445 x 310 x 300 h mm

MISURA 5P4



Dimensioni
535/452 x 472 x 300 h mm

MISURA 5



Dimensioni
720/636 x 472 x 300 h mm

COLORE	CO	C	5101	COLORE	CO	C	5101	COLORE	CO	C	5101	COLORE	CO	C	5101	COLORE	CO	C	5101
	CO	C4A2	5101		CO	C004	5101		CO	C4A5	5101		CO	Z5P4	5101		CO	Z005	5101
	CO	C4A2	5102		CO	C004	5102		CO	C4A5	5102		CO	Z5P4	5102		CO	Z005	5102
	CO	C4A2	5103		CO	C004	5103		CO	C4A5	5103		CO	Z5P4	5103		CO	Z005	5103
	CO	C4A2	5104		CO	C004	5104		CO	C4A5	5104		CO	Z5P4	5104		CO	Z005	5104
	CO	C4A2	5105		CO	C004	5105		CO	C4A5	5105		CO	Z5P4	5105		CO	Z005	5105
	Confezione pz. 14				Confezione pz. 10				Confezione pz. 6				Confezione pz. 18				Confezione pz. 12		
	Prezzo unitario €10,79				Prezzo unitario €12,23				Prezzo unitario €14,90				Prezzo unitario €27,96				Prezzo unitario €35,35		



CD C4A2 0099
Divisorio longit. zincato per misura 4A2
Confezione pz. 1
Prezzo unitario €7,38

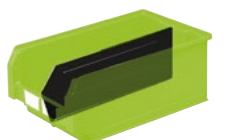

CD C004 7107
Divisorio longit. in plastica per misura 4
Confezione pz. 10
Prezzo unitario €3,86

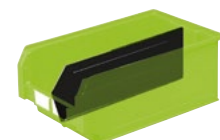

CD C4A5 7107
Divisorio longit. in plastica per misura 4A5
Confezione pz. 10
Prezzo unitario €5,39



CS Z5P4 0199
Divisorio longit. zincato con coppia supporti trasvers. mis. 5P4
Confezione pz. 1
Prezzo unitario €11,59



CS Z005 0199
Divisorio longit. zincato con coppia supporti trasvers. mis. 5
Confezione pz. 1
Prezzo unitario €12,62



COMPAT

C-PARTS



ECOGREEN

16



MISURA 1



Dimensioni
169/136 x 103 x 75 h mm

CO C001 5401

Confezione pz. 50

Prezzo unitario **€0,89**

MISURA 2



Dimensioni
230/202 x 150 x 125 h mm

CO C002 5401

Confezione pz. 54

Prezzo unitario **€1,84**

MISURA 3A2



Dimensioni
350/296 x 210 x 145 h mm

CO C3A2 5401

Confezione pz. 21

Prezzo unitario **€4,55**

MISURA 3



Dimensioni
350/291 x 210 x 200 h mm

CO C003 5401

Confezione pz. 15

Prezzo unitario **€5,31**

MISURA 4



Dimensioni
500/443 x 310 x 200 h mm

CO C004 5401

Confezione pz. 10

Prezzo unitario **€10,44**



CO C1S2 5407

Divisorio 2 scomparti
per misura 1

Confezione pz. 25

Prezzo unitario **€1,39**



CO C2S2 5407

Divisorio 2 scomparti
per misura 2

Confezione pz. 25

Prezzo unitario **€1,88**



CD C3A2 7107

Divisorio longit. in plastica
per misura 3A2

Confezione pz. 10

Prezzo unitario **€2,14**



CD C003 7107

Divisorio longit. in plastica
per misura 3

Confezione pz. 10

Prezzo unitario **€2,80**



CD C004 7107

Divisorio longit. in plastica
per misura 4

Confezione pz. 10

Prezzo unitario **€3,86**



CO C1S4 5407

Divisorio 4 scomparti
per misura 1

Confezione pz. 25

Prezzo unitario **€1,39**



CO C2S4 5407

Divisorio 4 scomparti
per misura 2

Confezione pz. 25

Prezzo unitario **€1,88**



L' Ecogreen rappresenta una soluzione ecologica poiché dona nuova vita alla plastica riciclata derivante dalla valorizzazione dei rifiuti plastici da post consumo.

FOX

STEEL



I carrelli portaminuteria **FOX** sono configurabili in diverse opzioni a seconda delle proprie necessità di stoccaggio. Disponibili con altezza 1430 mm, i carrelli FOX sono forniti di serie con ruote montate per facilitarne lo spostamento. Possono essere configurati in versione mono o bifronte e completati con mensole e cassette Compat, Zeus, Nextit o contenitori Practibox.



Dimensione carrello
1023 x 613 x 1430 h mm

FXT B001 5401

Prezzo unitario € 522,55



Completo di:

3 x Mensole inclinabili - prof. 420 mm

Portata mensola **50 KG**

CONTENITORI

9 x NEXIT 400 x 300 x 170 H mm

2 x NEXIT 600 x 400 x 170 H mm



Dimensione carrello
725 x 613 x 1430 h mm

FXT S001 5401

Prezzo unitario € 837,36



Completo di:

6 x Mensole inclinabili - prof. 220 mm

Portata mensola **50 KG**

CONTENITORI

4 x PRACTIBOX 6 CASSETTI + FERMI

4 x PRACTIBOX 5 CASSETTI + FERMI

12 x NEXIT 300 x 200 x 120 H mm



Dimensione carrello
1023 x 613 x 1430 h mm

FXT B002 5401

Prezzo unitario € 821,02



Completo di:

5 x Mensole inclinabili - prof. 320 mm

Portata mensola **50 KG**

9 x Mensole fisse

Portata mensola **25 KG**

CONTENITORI

45 x COMPAT MISURA 1

24 x COMPAT MISURA 2

6 x NEXIT 400 x 300 x 120 H mm

4 x NEXIT 400 x 300 x 170 H mm



Dimensione carrello
725 x 613 x 1430 h mm

FXT S002 5401

Prezzo unitario € 436,51



Completo di:

3 x Mensole inclinabili - prof. 420 mm

Portata mensola **50 KG**

CONTENITORI

4 x NEXIT 400 x 300 x 170 H mm

1 x NEXIT 600 x 400 x 170 H mm

1 x NEXIT 600 x 400 x 220 H mm



Dimensione carrello
1023 x 613 x 1430 h mm

FXT B003 5401

Prezzo unitario € 755,36



Completo di:

15 x Mensole fisse

Portata mensola **25 KG**

CONTENITORI

45 x COMPAT MISURA 1

24 x COMPAT MISURA 2

28 x COMPAT MISURA 3A2



Dimensione carrello
725 x 613 x 1430 h mm

FXT S003 5401

Prezzo unitario € 910,93



Completo di:

14 x Mensole inclinabili - prof. 220 mm

Portata mensola **50 KG**

CONTENITORI

30 x COMPAT MISURA 1

44 x COMPAT MISURA 2

Tutto in ordine e ben in vista per un magazzino flessibile e funzionale: questo è il risultato ottenuto dallo studio e dalla realizzazione delle cassette in polipropilene serie **RK** e degli appositi scaffali per il loro contenimento. Disponibili in undici diverse misure per rispondere ad ogni esigenza.

18

**DISPONIBILI ANCHE IN:
PROFONDITÀ 300 / 600 mm
ESD (CONDUTTIVO)**

PROFONDITÀ 400 mm

PROFONDITÀ 500 mm



Dimensioni
120 x 400 x 100 h mm

Dimensioni
160 x 400 x 100 h mm

Dimensioni
240 x 400 x 100 h mm

Dimensioni
120 x 500 x 100 h mm

Dimensioni
160 x 500 x 100 h mm

Dimensioni
240 x 500 x 100 h mm

RK	4012	5104	RK	4016	5104	RK	4024	5104	RK	5012	5104	RK	5016	5104	RK	5024	5104
Confezione pz.	32		Confezione pz.	24		Confezione pz.	16		Confezione pz.	32		Confezione pz.	24		Confezione pz.	16	
Prezzo unitario	€5,12		Prezzo unitario	€5,62		Prezzo unitario	€7,08		Prezzo unitario	€5,79		Prezzo unitario	€6,01		Prezzo unitario	€7,90	



Divisorio trasversale
per cassette 4012/5012



Divisorio trasversale
per cassette 4016/5016



Divisorio trasversale
per cassette 4024/5024



Divisorio longitudinale
zincato per cassette
4016/4024



Divisorio longitudinale
zincato per cassette
5016/5024

RK	D120	6896	RK	D160	6896	RK	D240	6896	RK	D400	0099	RK	D500	0099
Confezione pz.	1		Confezione pz.	1		Confezione pz.	1		Confezione pz.	1		Confezione pz.	1	
Prezzo unitario	€0,76		Prezzo unitario	€0,84		Prezzo unitario	€1,34		Prezzo unitario	€3,73		Prezzo unitario	€4,28	

PROFONDITÀ 400 mm

PROFONDITÀ 500 mm



Dimensioni
120 x 400 x 100 h mm

Dimensioni
160 x 400 x 100 h mm

Dimensioni
240 x 400 x 100 h mm

Dimensioni
120 x 500 x 100 h mm

Dimensioni
160 x 500 x 100 h mm

Dimensioni
240 x 500 x 100 h mm

RK	4012	5401	RK	4016	5401	RK	4024	5401	RK	5012	5401	RK	5016	5401	RK	5024	5401
Confezione pz.	32		Confezione pz.	24		Confezione pz.	16		Confezione pz.	32		Confezione pz.	24		Confezione pz.	16	
Prezzo unitario	€4,11		Prezzo unitario	€4,48		Prezzo unitario	€5,66		Prezzo unitario	€4,62		Prezzo unitario	€4,80		Prezzo unitario	€6,32	

RK-BOX

C-PARTS



Scaffale per la collocazione delle cassette serie **RK**. Realizzati in acciaio di colore grigio RAL 7000 - possono essere sovrapposti ed essere rialzati ed isolati dal pavimento grazie ad un apposito zoccolo in lamiera d'acciaio verniciata.

**DISPONIBILI ANCHE IN:
PROFONDITÀ 300 e 600 mm**

19

PROFONDITÀ 400 mm



Dimensioni
500 x 400 x 545 h mm

RK	BX41	5104
16 cassette		RK 4012
Confezione pz.		☒ 1
Prezzo unitario		€233,80



Dimensioni
500 x 400 x 545 h mm

RK	BX42	5104
12 cassette		RK 4016
Confezione pz.		☒ 1
Prezzo unitario		€203,74



Dimensioni
500 x 400 x 545 h mm

RK	BX44	5104
8 cassette		RK 4024
Confezione pz.		☒ 1
Prezzo unitario		€177,59



Zoccolo profondità 400 mm

RK F400 0001

Confezione pz. ☒ 1

Prezzo unitario **€28,16**

Zoccolo profondità 500 mm

RK F500 0001

Confezione pz. ☒ 1

Prezzo unitario **€54,60**

PROFONDITÀ 500 mm



Dimensioni
500 x 500 x 545 h mm

RK	BX51	5104
16 cassette		RK 5012
Confezione pz.		☒ 1
Prezzo unitario		€261,66



Dimensioni
500 x 500 x 545 h mm

RK	BX52	5104
12 cassette		RK 5016
Confezione pz.		☒ 1
Prezzo unitario		€224,73



Dimensioni
500 x 500 x 545 h mm

RK	BX54	5104
8 cassette		RK 5024
Confezione pz.		☒ 1
Prezzo unitario		€199,40



☒ Sovrapponibili con scaffali della stessa profondità e di profondità decrescente per sfruttare al massimo lo spazio disponibile.

☒ *Completi di guide e fermi per cassette.*



Consulta il nostro catalogo per altre configurazioni e misure disponibili.

imilani
Innovative Italian Ideas

CONTAINER

LOGISTIC



CONTAINER stampati ad iniezione e realizzati in Polietilene Alta Densità (PEHD) e rigenerato (R-PE), anche per uso alimentare. Materiale completamente riciclabile, di prima fusione garantito e certificato. Facilmente lavabile ed inattaccabile dalla ruggine; insensibile a variazioni di peso a contatto con l'acqua. Particolarmente resistente ai raggi U.V. ed infrarossi, alle alte e basse temperature, agli acidi ed alcali. Strutturato in maniera da essere impilabile, per agevolare le operazioni di stoccaggio e di movimentazione.

20



Rigenerato



Rigenerato



Rigenerato



Dimensioni
1000x640x655hmm

Dimensioni
1000x640x655hmm

Dimensioni
1165x790x800hmm

Dimensioni
1165x790x800hmm

Dimensioni
1165x790x800hmm

Dimensioni
1165x790x800hmm

CN 1006FJ 4001

CN 1006FJ 4007

CN 1107FJ 4001

CN 1107FJ 4007

CN 1107SJ 4001

CN 1107SJ 4007

Volume 280 L

Volume 280 L

Volume 520 L

Volume 520 L

Volume 520 L

Volume 520 L

Portata 150 kg

Portata 150 kg

Portata 250 kg

Portata 250 kg

Portata 250 kg

Portata 250 kg

Prezzo unitario € 82,65

Prezzo unitario € 67,42

Prezzo unitario € 168,02

Prezzo unitario € 140,84

Prezzo unitario € 177,26

Prezzo unitario € 148,98



SPEDIZIONE IN 7 GIORNI

Fornito con ruote montate



4x ruote girevoli
Ø 100 mm senza freno

4x ruote girevoli
Ø 125 mm senza freno

Coperchio separato

Coperchio separato

Dimensioni
1000x640x790hmm

Dimensioni
1165x790x960hmm

Dimensioni
1000 x 640 mm

Dimensioni
1165 x 790 mm

CN 1006R1J 4001

CN 1107R2J 4001

CN CV10 4001

CN CV11 4001

Volume 280 L

Volume 520 L

Confezione pz. 1

Confezione pz. 1

Portata 150 kg

Portata 250 kg

Prezzo unitario € 36,97

Prezzo unitario € 45,68

Prezzo unitario € 157,34

Prezzo unitario € 245,84



Raccolta

Batterie esauste



Raccolta

Batterie esauste

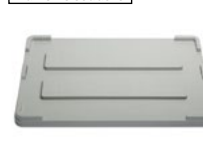

Coperchio separato

Dimensioni
1200x1000x760hmm

Dimensioni
1200 x 1000 mm

CN 1210BJ 4001

CN CV12 4001

Volume 610 l

Confezione pz. 1

Portata 450 kg

Prezzo unitario € 58,73

Prezzo unitario € 240,99

TAPPETI

AUTOMOTIVE



Questi **TAPPETI**, realizzati in PE-LD (polietilene a bassa densità), sono particolarmente adatti nelle officine meccaniche, nelle industrie per la lavorazione del metallo, negli impianti di lavaggio, nelle industrie alimentari, nei depositi, negli stabilimenti balneari, nei camping, nei guardaroba, ecc.

TAPPETO ANTISTRUCCIOLO CHIUSO



Dimensioni
800 x 400 x 25 h mm

COLORE	CA 0804A 4101
	CA 0804A 4106
	CA 0804A 4107

Confezione pz. 4

Prezzo unitario **€17,76**

TAPPETO ANTISTRUCCIOLO FORATO

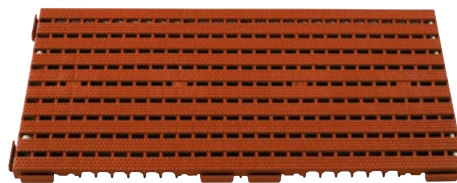

Dimensioni
800 x 400 x 25 h mm

COLORE	CA 0804B 4101
	CA 0804B 4106
	CA 0804B 4107

Confezione pz. 4

Prezzo unitario **€16,41**

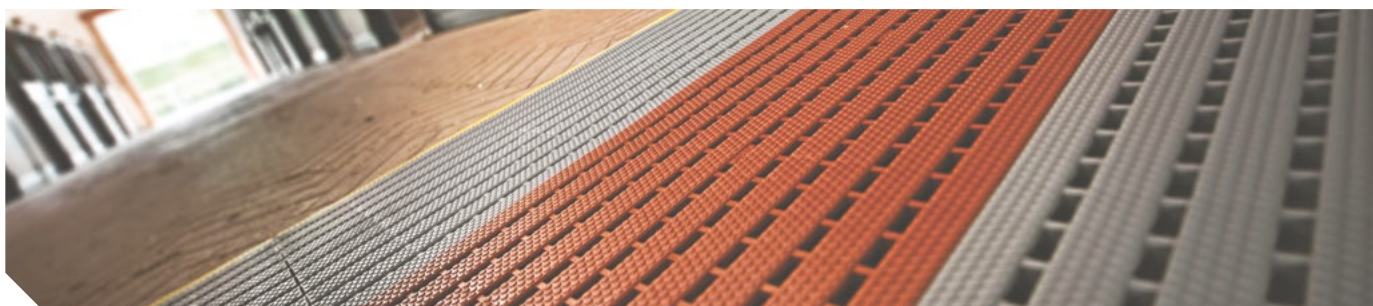

Tutte le parti possono essere unite e rimosse in modo semplice e rapido grazie all'apposito sistema di clip zincate di aggancio.

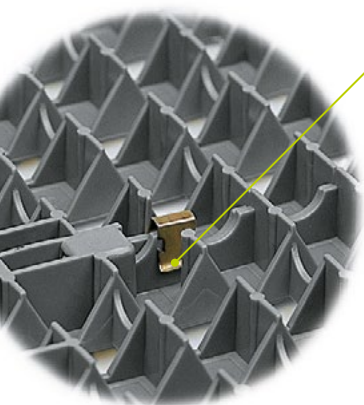

Rampa di raccordo lineare

CA 0401A 4105

400 x 120 x 25 h mm

Confezione pz. 20

Prezzo unitario **€3,86**



Rampa di raccordo ad angolo

CA 0101A 4105

120 x 120 x 25 h mm

Confezione pz. 10

Prezzo unitario **€2,16**



Clip zincata di collegamento

CA CLIP

Confezione pz. 10

Prezzo unitario **€0,20**

SQUARE

STEEL

RAL
7000

Gli scaffali **SQUARE** sono sovrapponibili e possono creare vere e proprie pareti attrezzate, in base agli spazi disponibili. Gli scaffali SQUARE sono realizzati con struttura in acciaio colore grigio RAL7000, in 8 diverse configurazioni, sia per cassette serie Zeus che per contenitori serie Compat.

22

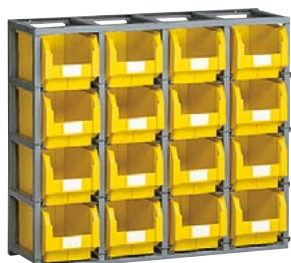

 **Contenitori esclusi**



 **Contenitori esclusi**

Dimensioni			Telai sovrapposti		Dimensioni			Telai sovrapposti	
1025 x 310 x 885 h mm			2	max 3	1765 x 310 x 885 h mm			2	max 3
SQ	160	03	Portata max 1+1 telai	Portata max 1+2 telai	SQ	280	03	Portata max 1+1 telai	Portata max 1+2 telai
Q.tà max cassette			960 kg	640 kg	Q.tà max cassette			1680 kg	1120 kg
Adatta per contenitori COMPAT			Portata di ogni box		Adatta per contenitori COMPAT			Portata di ogni box	
mis. 3			60 kg	40 kg	mis. 3			60 kg	40 kg
Prezzo unitario					Prezzo unitario				
€ 270,27					€ 401,72				



Zoccolo

SQ B10 23

1020 x 315 x 85 h mm

Prezzo unitario € 65,45



Coperchio para polvere

SQ C10 23

1020 x 315 x 20 h mm

Prezzo unitario € 31,44



Zoccolo

SQ B17 63

1765 x 315 x 85 h mm

Prezzo unitario € 89,68



Coperchio para polvere

SQ C17 63

1765 x 315 x 20 h mm

Prezzo unitario € 40,98



 **Contenitori esclusi**

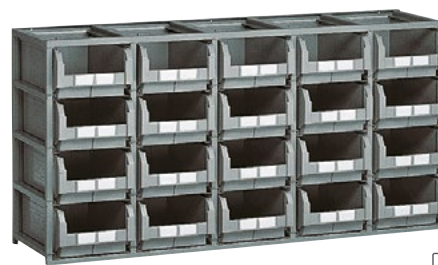

 **Contenitori esclusi**

Dimensioni			Telai sovrapposti		Dimensioni			Telai sovrapposti	
1075 x 460 x 885 h mm			max 3		1765 x 460 x 885 h mm			max 3	
SQ	120	04	Portata di ogni telaio		SQ	200	04	Portata di ogni telaio	
Q.tà max cassette			1200 kg		Q.tà max cassette			1600 kg	
Adatta per contenitori COMPAT			Portata di ogni box		Adatta per contenitori COMPAT			Portata di ogni box	
mis. 4			100 kg		mis. 4			80 kg	
ZEUS mis. 272-4					ZEUS mis. 272-4				
Prezzo unitario					Prezzo unitario				
€ 257,92					€ 364,85				



Zoccolo

SQ B10 74

1070 x 465 x 85 h mm

Prezzo unitario € 76,30



Coperchio para polvere

SQ C10 74

1070 x 465 x 20 h mm

Prezzo unitario € 37,40



Zoccolo

SQ B17 64

1075 x 465 x 85 h mm

Prezzo unitario € 84,13



Coperchio para polvere

SQ C17 64

1765 x 465 x 20 h mm

Prezzo unitario € 41,13

SCOPRI

LA GAMMA DI STRUTTURE PORTA CONTENITORI IN PRONTA CONSEGNA



QUICK



FRAME



PICK

Disponibile con

NEXIT

KRONOS



QUICK



FRAME

Disponibile con

COMPAT

ZEUS



PICK

Altezze disponibili

1000 / 1655 / 2000 h mm

RICHIEDI UN PREVENTIVO

www.imilani.com

Varietà



**PIÙ DI 1500 PRODOTTI
DISPONIBILI A MAGAZZINO**

Velocità

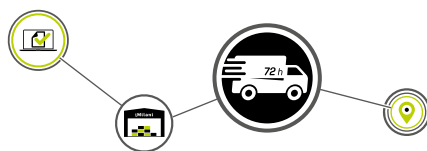

SPEDIZIONI IN 72 ore*
* salvo disponibilità a magazzino

Qualità



**5 ANNI DI GARANZIA SU
TUTTI I PRODOTTI**



Dimensioni
594 x 396 x 173 h mm

MO 64TP 5107

4 ruote girevoli
in termoplastico grigio
Ø 100 mm

Confezione pz. 1

Prezzo unitario **€51,11**

MOTION

LOGISTIC



5
PP

Carrello realizzato in polipropilene ad alto impatto, adatto al trasporto di contenitori 600x400 e 400x300. Possibilità di essere impilato quando non in uso grazie ad un semplice sistema di collegamento è possibile creare file di carrelli per un'unica movimentazione.



IMPILAGGIO



SISTEMA DI COLLEGAMENTO



MO HELM

Timone telescopico
regolabile in altezza

Confezione pz. 1

Prezzo unitario **€44,15**



Via Jacopo Linussio, 1
33170 Pordenone (PN)
Tel. 0434 630825/6
Fax 0434 639721
info@viteria2000.it
www.viteria2000.it

Filiale di Ancona
Via Guglielmo Marconi, 8
60125 Ancona (AN)
Tel. 344 1200215
ancona@viteria2000.it

Movint
Viale Venezia, 20
31015 Conegliano (TV)
Tel. 0438 453570
movint@movint.it

Filiale di Marghera
Via delle Industrie, 23
30175 Venezia VE
Tel. 041 937657
info@viteria2000.it

VITERIA 2000 Srl
P. IVA 01398380939

Filiale di Genova
Via Giacomo Solimani, 62
16154 Genova (GE)
Tel. 348 8908708
genova@viteria2000.it

Filiale di Monfalcone
Via Callisto Cosulich, 42
34074 Monfalcone (GO)
Tel. 0481 485512
monfalcone@viteria2000.it

iMilani
innovative
italian
ideas

iMilani srl - SB

Via Capitano Alessio, 109
36027 Rosà (VI) - Italy

Tel +39 0424 583100
info@imilani.it
www.imilani.com

A brand of:
i'M



RICHIEDI IL CATALOGO GENERALE

imilani07231T